

**CONFIDENTIAL**

본 자료는 동남산업 정보로 임의 유출을 금지합니다.

REV	REVISION RECORD	BY	DATE
A	INITIAL RELEASE		2009.06.22
B	CHANGED PAD SIZE & QUANTITY PER REEL		2009.08.31
C	MODIFIED GAP DIMENSION & TOLERANCE		2009.12.10

**NOTES: UNLESS OTHERWISE SPECIFIED**

1. ALL DIMENSIONS APPLY AFTER PLATING.
2. DIMENSION IN FREE STATE.
3. RECOMMENDED SHIELD THICKNESS =  $0.15 \pm 0.015$

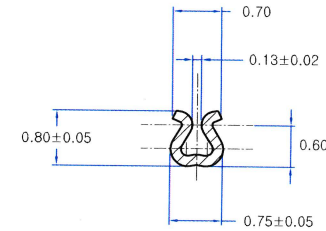
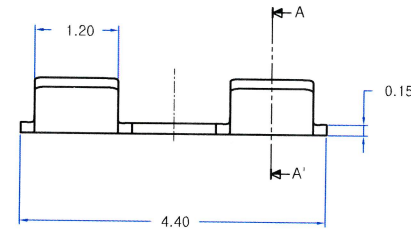
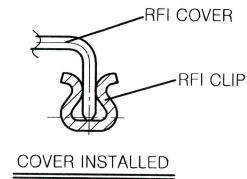
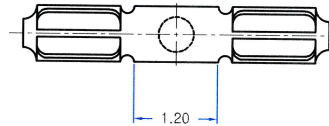

SECTION A-A'

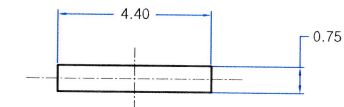

RECOMMENDED PAD SIZE

PICK-UP AREA

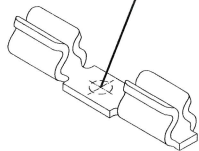

ISOMETRIC VIEW

12mm TAPE PER E.I.A. STD. 481 , 13" REEL ,  
SEE TABLE FOR QTY OF PARTS PER REEL.

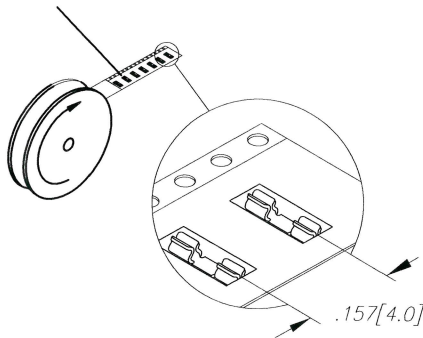

MATERIAL <b>SUS301</b>	HEAT TREAT	UNLESS OTHERWISE SPECIFIED ALL DIMENSIONS ARE IN MM. TOLERANCES ARE: 0 ≤ X < 3 : ±0.10 3 ≤ X < 10 : ±0.15 10 ≤ X < 25 : ±0.20 25 ≤ X : ±0.25	오투스프라이스(주) www.autosplice.co.kr 1-87-32-812 / 9784	동남산업(주) www.dnant.co.kr 1-82-32-521-1650
FINISH <b>POST-TIN (MATTE)</b>	Unit Qty <b>10,000PCS / REEL</b>		PROJECT	DRAWN BY <b>Y.J.PARK</b> DATE <b>2009.06.22</b> DESIGNED BY <b>Y.J.PARK</b> DATE <b>2009.06.22</b> APPROVED BY <b>J.H.LEE</b> DATE <b>2009.06.22</b>
This drawing and the information set forth hereon are the property of Autosplice, Inc. and are to be held in trust and confidence. Publication, disclosure, or use for any purpose not expressly authorized in writing by Autosplice, Inc. is prohibited.				
TITLE <b>SMT RFI CLIP - MICROMINIATURE</b>			SIZE <b>A4(mm)</b>	DRAWING NUMBER <b>C-ATC-AA-01-001</b>
SCALE N/S		WEIGHT	SHEET 1 1 OF	